

airmaster



200L BELT DRIVEN AIR COMPRESSOR MODEL NO: AIRMASTER 18/200

PART NO: 2245311

OPERATION & MAINTENANCE INSTRUCTIONS



ORIGINAL INSTRUCTIONS

GC1022 rev 2

INTRODUCTION

Thank you for purchasing this CLARKE 200L Air Compressor.

Before attempting to operate the machine, it is essential that you read this manual thoroughly and follow all instructions given. This will ensure the safety of yourself and others and you can look forward to the product giving you long and satisfactory service.

GUARANTEE

This CLARKE product is guaranteed against faulty manufacture for a period of 12 months from the date of purchase. Please keep your receipt as proof of purchase.

This guarantee is invalid if the product is found to have been abused or tampered with in any way, or not used for the purpose for which it was intended.

Faulty goods should be returned to their place of purchase, no product can be returned to us without prior permission. This guarantee does not effect your statutory rights.

ENVIRONMENTAL RECYCLING POLICY



Through purchase of this product, the customer is taking on the obligation to deal with the WEEE in accordance with the WEEE regulations in relation to the treatment, recycling & recovery and environmentally sound disposal of the WEEE.







In effect, this means that this product must not be disposed of with general household waste. It must be disposed of according to the laws governing Waste Electrical and Electronic Equipment (WEEE) at a recognised disposal facility.

SAFETY PRECAUTIONS

Before using your compressor it is in your own interest to read and pay attention to the following safety precautions.

1. Compressed air is dangerous. DO NOT point a jet of air at persons or animals, and do not discharge compressed air against the skin.
2. DO NOT operate your compressor with the guard removed.
3. Repairs must only be carried out by a qualified engineer. If problems occur, contact your CLARKE dealer.
4. Before carrying out any maintenance make sure that the pressure is released from the air reservoir and that the compressor is disconnected from the electrical supply.
5. DO NOT leave pressure in the receiver overnight or when transporting.
6. DO NOT adjust or tamper with the safety valves. The maximum pressure is factory set, and clearly marked on the compressor.
7. DO NOT operate in wet or damp conditions. Keep the compressor dry at all times. Similarly, clean air will allow the compressor to work efficiently. DO NOT use in dusty or otherwise dirty locations.
8. Some of the metal parts can become quite hot during operation. DO NOT touch/ remove these until the compressor has cooled down.
9. ALWAYS set any pressure regulator to the recommended setting for the tool.
10. When spraying flammable materials e.g. cellulose paint, ensure that there is sufficient airflow and keep clear of any source of ignition.
11. Before spraying any material always consult paint manufacturers instructions for safety and usage.
12. Protect yourself. Goggles will protect your eyes from flying particles. Face masks will protect you against paint spray and fumes.
13. DO NOT apply strain to electrical cables and make sure that air hoses are not kinked or wrapped around the compressor.
14. When disconnecting air hoses or other equipment from your compressor, make sure that the air supply is turned off at the outlet and vent all pressurised air from within the reservoir and other equipment attached to it.
15. Make sure that children and animals are kept well away from the compressor and any equipment attached to it.
16. Make sure that all individuals using the compressor have had any necessary training and have read and fully understand these operating instructions.
17. Make sure that any equipment or tool used in conjunction with your compressor, has a safe working pressure exceeding that of the compressor.
18. Be careful when transporting the compressor to prevent tipping over.
19. Permanently installed systems must be installed by a competent engineer.
20. These compressors produce noise levels in excess of 70dB(A). Persons working near the compressor must be supplied with ear protection.

SAFETY SYMBOLS

	<p>Read this instruction booklet carefully before positioning, operating or adjusting the compressor.</p>
	<p>Risk of electric shock. The compressor must be disconnected from the mains supply before removing any covers. DO NOT use in a damp environment.</p>
	<p>Risk of accidental start-up. The compressor could start automatically in the event of a power cut and subsequent reset. DO NOT move the compressor while it is connected to the power source, or when the tank is filled with compressed air.</p>
	<p>This compressor contains surfaces which may reach a high temperature during operation. NEVER operate with the motor housing removed.</p>
	<p>Wear safety goggles when using this compressor</p>
	<p>Wear ear protectors when using this compressor</p>
 <p>LWA</p> <p>97 dB</p>	<p>This compressor produces a high sound level during operation.</p>

INSTALLATION

Before installing your compressor, confirm that its output will be sufficient for the airline equipment to be used. We recommend the following:

1. A firm, level site and the use of floor mountings with anti-vibration pads. (Do not bolt the machine directly to the floor).
2. A dust and damp free environment.
3. Adequate ventilation for:
 - Air intake to the compressor
 - Cooling for the compressor and its electric motor.
4. Sufficient access for servicing. (A minimum clearance of 500mm must be allowed around the machine).
5. The power cable must be adequate to carry the starting and running load of the electric motor. This is particularly relevant if the compressor is some distance from the source of supply.
6. Electrical installations should be completed by a qualified electrician.

ELECTRICAL CONNECTIONS



WARNING: READ THESE ELECTRICAL SAFETY INSTRUCTIONS THOROUGHLY BEFORE CONNECTING THE PRODUCT TO THE MAINS SUPPLY.

Connect the three core mains cable to a suitable industrial supply isolator, or heavy duty plug meeting the requirements of BS EN 60309. This compressor must be connected to a supply having a rated capacity of greater than 16 Amps.

A normal 13 Amp (BS1363) plug must NOT be used.

WARNING: THIS APPLIANCE MUST BE EARTHED.

IMPORTANT: The wires in this mains lead are coloured in accordance with the following code:

GREEN AND YELLOW - EARTH (E)

BLUE - NEUTRAL (N)

BROWN - LIVE (L)

As the colours of the flexible cord of this appliance may not correspond with the coloured markings identifying terminals, proceed as follows:

- Connect GREEN AND YELLOW coloured cable to terminal marked "E" or Earth Symbol or coloured Green and Yellow.
- Connect BROWN cable to terminal marked 'L' or coloured Red.

Connect BLUE cable to terminal marked "N" or coloured Black.

BEFORE USE



CAUTION: TO PREVENT INJURY, GET ASSISTANCE WHEN LIFTING OR MOVING THIS COMPRESSOR.

Before connecting your compressor to the power supply, check the following:

- Set the ON/OFF switch to the OFF position (pushed down).
- Make sure that the compressor is on level ground.
- Make sure that the supply voltage matches the voltage shown on the data label.



CHECK THE OIL LEVEL

1. Ensure the oil level is filled up to the mark on the sightglass.
2. If low, top up after unscrewing the filler plug.
 - Only use ISO100 (SAE30) compressor oil, available from your Machine Mart dealer Part No. 3050796.
 - Take care not to overfill.

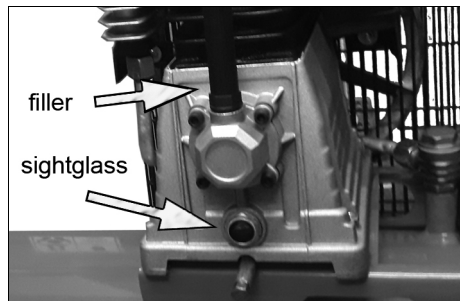

OPERATION

If the compressor has not been used for more than 24 hours, open the drain valve (on the bottom of the reservoir) and drain any condensate which has collected. See page 10.

MOVING THE AIR COMPRESSOR

- Stop the compressor and disconnect it from the power supply before you move it.
- DO NOT lift by (or put strain on) valves or hoses.
- Avoid moving the machine if the tank is fully pressurised.

ATTACHING AIR TOOLS



WARNING: BEFORE CONNECTING AIR TOOLS, MAKE SURE THAT YOU READ THE INSTRUCTIONS SUPPLIED WITH THE TOOL, ALSO ENSURE THAT THE TOOL IS SUITABLE FOR USE WITH THE COMPRESSOR AND HOSE SPECIFICATIONS.

1. Attach the air hose to the outlet valves.
2. Attach the air tool to the other end of the air hose.

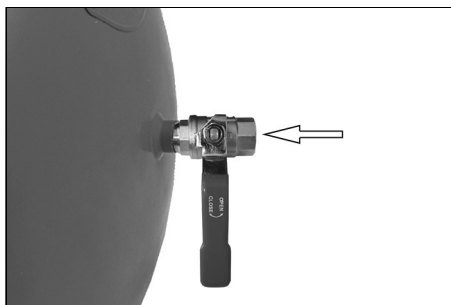

3. Turn the outlet valve handle to the on position.

NOTE: The outlet valve is shown without the air hose fitted for clarity.

NOTE: To adjust the output pressure we recommend that a pressure regulator (not supplied) be fitted between the compressor and the tool.

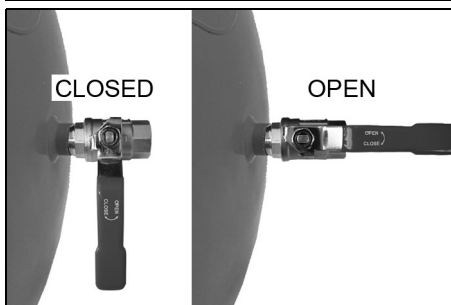

TURNING THE COMPRESSOR ON

1. Plug the compressor into the power supply.
2. Lift the On/Off button.
 - The compressor will operate until the reservoir is fully pressurised. It will then shut down.
 - The compressor will start up again when the pressure in the reservoir decreases.

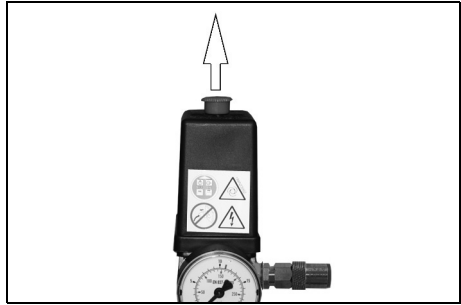

CHECKING THE SAFETY VALVE

To make sure that the safety valve works correctly;

1. Unscrew and pull the knurled part of the safety valve.
 - Air will be released when you pull hard on the valve end and stop when released.
2. If the valve does not operate in this way, do not use the compressor. The compressor must be repaired by a qualified service agent.
3. Once tested, screw the knurled part back.

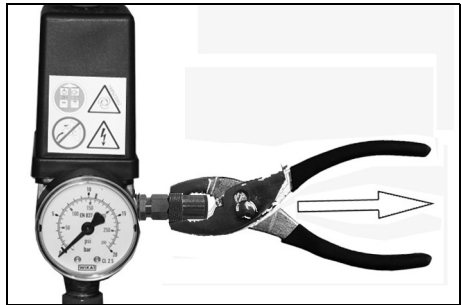

WARNING: DO NOT REMOVE OR TRY TO ADJUST THE SAFETY VALVE.



REMOVING TOOLS FROM THE AIR HOSE

1. Push down on the On/Off button to stop the compressor.



2. Turn the outlet valve handle to the off position.
3. Operate the tool to depressurise the air hose.
4. Disconnect the tool from the hose.

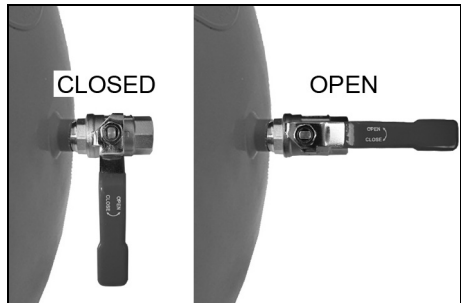

TURNING THE COMPRESSOR OFF

1. Follow steps 1-3 in "Removing Tools from the Air Hose" above.
2. Disconnect the compressor from the power supply.
3. Slowly open the outlet valve to depressurise the reservoir.
 - You will hear a hissing sound as the reservoir depressurises.
4. Do not leave the compressor unattended if the reservoir is pressurised.

DRAINING THE RESERVOIR



CAUTION: YOU MUST DRAIN THE RESERVOIR AFTER EACH DAYS USE AND BEFORE YOU PUT YOUR COMPRESSOR INTO STORAGE.

1. Turn the compressor off and disconnect from the power supply.
2. Put a container below the drain valve to collect the condensate.
3. Open the drain valve slowly.
 - Condensation will drain from the reservoir.
4. Close the drain valve when the reservoir has fully drained.

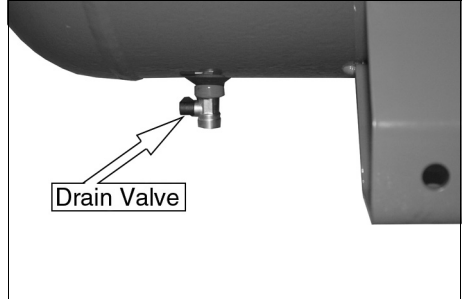

USING THE RESET BUTTON

This compressor has a thermal overload device.

If the motor gets too hot, the thermal overload device cuts the power which prevents damage to the motor.

If the thermal overload device operates, let the motor cool down for 5 minutes and push the reset button.

If you start the compressor and the overload cutout operates again, stop the compressor and disconnect from the power supply and have your compressor examined by a qualified service agent.

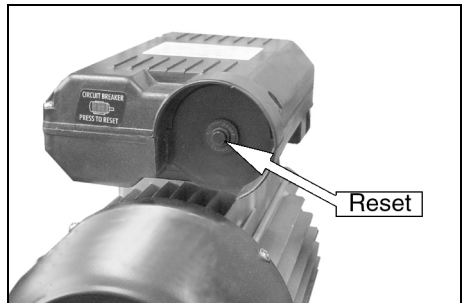

MAINTENANCE



WARNING: MAKE SURE THAT THE COMPRESSOR IS DISCONNECTED FROM THE ELECTRICAL SUPPLY BEFORE CARRYING OUT ANY MAINTENANCE

DRAIN THE RESERVOIR

After use, always open the drain valve to make sure that any condensate is drained off.

CHECKING THE OIL

Ensure the oil level is between the min and max marks on the dipstick. See "Check the Oil level" on page 6 and top-up if necessary - (use ISO100 (SAE30) compressor oil, available from your local Machine Mart dealer).

CLEANING THE AIR FILTER

The air filter must be examined monthly or more often in dusty conditions.

1. Remove the securing bolt with a 7/32" hex key and pull the filter from the engine.
2. Remove the filter element and clean the filter using a soft brush.

- If necessary, the filter can be carefully cleaned in warm soapy water.
- Rinse and let the filter dry completely before refitting.
- If the filter or filter element is damaged you must replace it.

3. Reassemble the filter and refit it to the compressor.

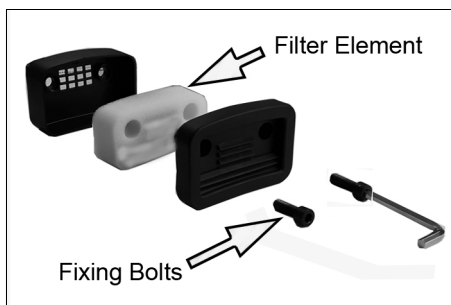

REPLACING THE OIL

After the first 100 hours use, replace the oil using SAE30 compressor oil. Then replace the oil after every 500 hours of operation or every 6 months.

To empty the oil from the machine, remove the oil drain plug from the crankcase.

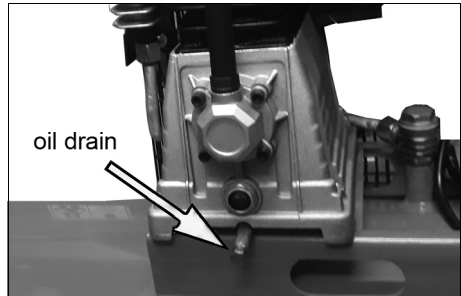

CHECKING THE NON-RETURN VALVE

If the reservoir pressure decreases for no apparent reason, it is possible that the non-return valve is leaking. To check this;

1. Make sure that the reservoir is not under pressure and the compressor is switched OFF.
2. Examine the non-return valve, and replace the gasket and valve if necessary.

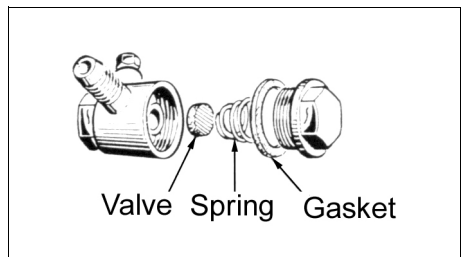
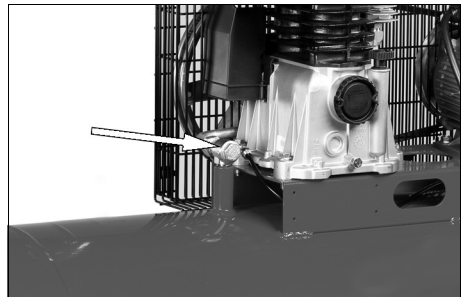

REPLACING THE DRIVE BELT

WARNING: MAKE SURE THAT THE COMPRESSOR IS DISCONNECTED FROM THE ELECTRICAL SUPPLY BEFORE REPLACING THE DRIVE BELT.



1. Rotate the clips on the front of the safety cage.
2. Remove the front of the cage and take out the worn or broken drive belt.

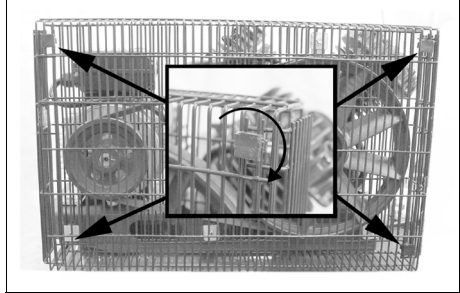

3. Place the new drive belt over the small pulley.

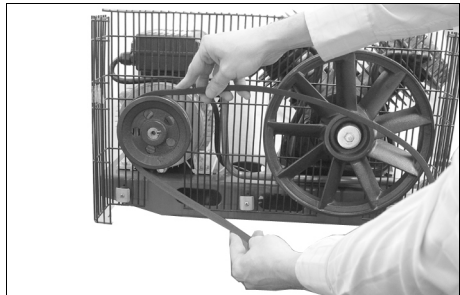

4. Position part of the drive belt over the large pulley as shown.

5. Rotate the large pulley by hand in a clockwise direction whilst guiding the belt on to it.

- Take care to avoid trapping your fingers between the pulley and belt.

6. Replace the cage and secure before use.

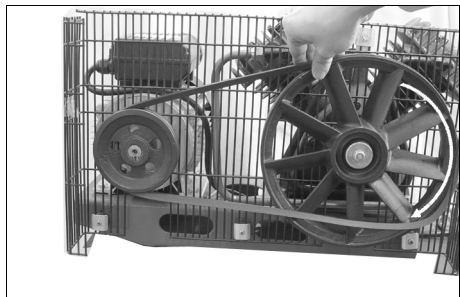

WARNING: NEVER USE THE COMPRESSOR WITH THE GUARD REMOVED.



TROUBLESHOOTING



CAUTION: DO NOT TRY TO REPAIR OR ADJUSTMENT IF YOU ARE UNCERTAIN. IF YOU HAVE ANY QUERIES, CONTACT YOUR CLARKE DEALER.

PROBLEM	PROBABLE CAUSE	REMEDY
The compressor has stopped and does not start.	Bad electrical connections.	1. Check electrical connections. 2. Clean and tighten if necessary.
	Overload cutout switch has tripped.	1. Switch off and wait approx 5 minutes. 2. Press the reset button and switch on again.
	Motor windings burnt out.	1. Contact your Machine Mart dealer for a replacement motor.
The compressor does not reach the set pressure and overheats easily.	Compressor head gasket blown or valve broken.	1. Return the machine to your nearest Machine Mart dealer.
Compressor does not start.	The reservoir has already fully pressurised.	1. Open drain valve to expel air. Compressor should start again when pressure reduces.
Air leaking from the non-return valve when the compressor is not running.	Faulty non-return valve.	1. Drain receiver completely of air. 2. Remove the valve end plug. 3. Carefully clean the valve seat and the gasket 4. Reassemble.
Compressor is very noisy and makes metallic knocking sound.	Compressor is damaged and needs overhaul.	1. Return the machine to your nearest Machine Mart dealer.

COMPONENT PARTS

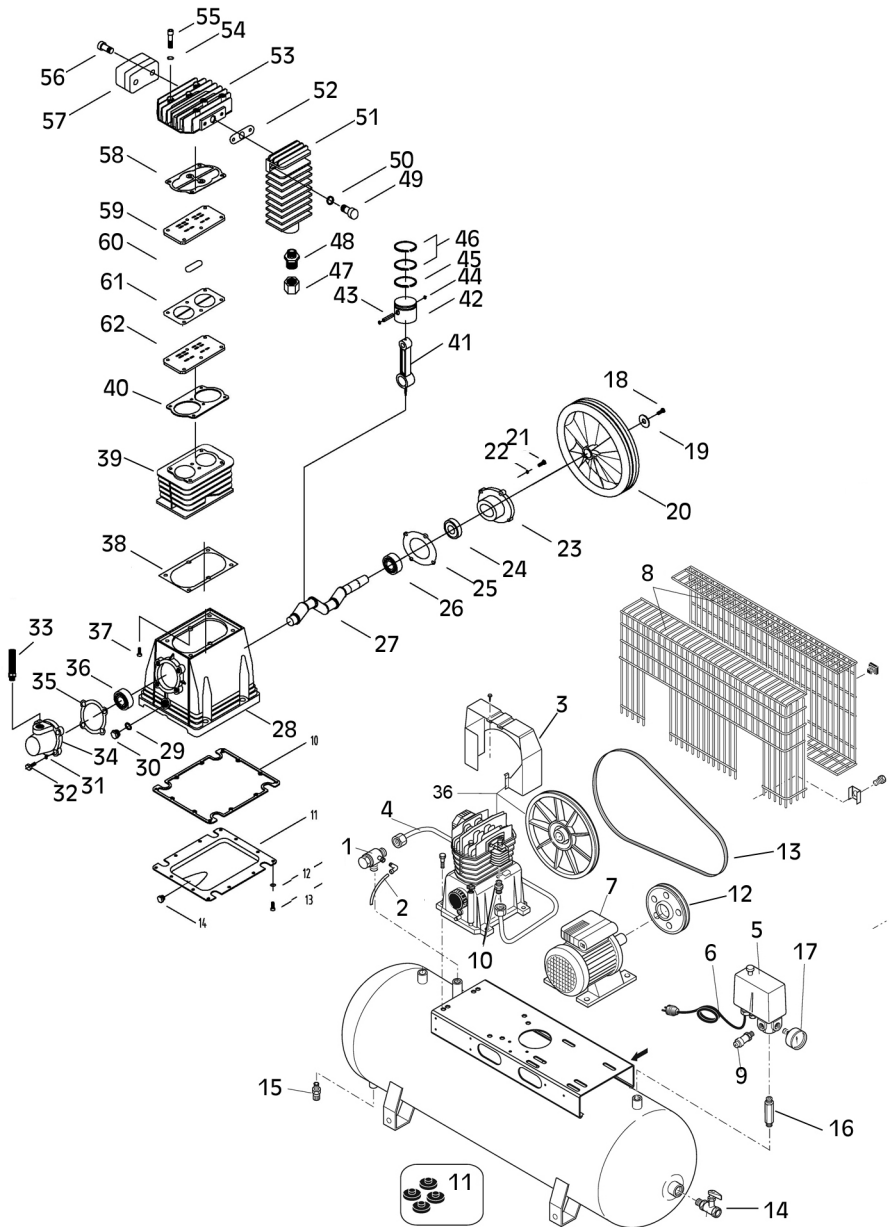

COMPONENT PARTS LIST

NO	DESCRIPTION
1	Non Return Valve
2	Rilsan Tube
3	Plastic Shroud
4	Delivery pipe
5	Pressure Switch
6	Power Cable
7	Motor
8	Belt Guard
9	Safety valve
10	Connector
11	Rubber feet (set)
12	Drive pulley
13	Drive Belt
14	Outlet Tap
15	Drain Valve
16	Upright Connector
17	Pressure Gauge
18	Bolt
19	Washer
20	Flywheel
21	Bolt
22	Washer
23	Bearing retainer
24	Bearing
25	Seal plate
26	Bearing
27	Crankshaft
28	Crankcase
29	O-ring
30	Sightglass
31	Washer

NO	DESCRIPTION
32	Bolt
33	Oil filler
34	End cap
35	Gasket
36	Bearing
37	Bolt
38	Gasket
39	Cylinder block
40	Head gasket
41	Connecting rod
42	Piston
43	Gudgeon pin
44	Circlip
45	Oil ring
46	Compression rings
47	Special nut
48	Adapter
49	Bolt
50	Washer
51	Air cooler
52	Spacer
53	Cylinder head
54	Washer
55	Bolt
56	Bolt
57	Air filter
58	Valve assembly
59	Upper plate
60	Seal
61	Valve plate
62	Lower plate

SPECIFICATIONS

MODEL	AIRMASTER 18/200
Part Number	2245311
Motor size	4HP
Voltage	230 VAC (50Hz)
Air Displacement	504.8L/min (18 CFM)
Max Pressure	10 Bar (145psi)
Receiver Capacity	200 L
Ingress Protection	IP20
Duty cycle	S3/50%
Oil requirements	Compressor oil SAE30
Oil capacity	0.4L
Dimensions (L x W x H)	1540 x 400 x 820 mm
Guaranteed Sound Power Level	97 dB(A)
Weight	102 kg

Please note that the details and specifications contained herein, are correct at the time of going to print. We reserve the right to change specifications at any time without prior notice.

DECLARATION OF CONFORMITY



Product Description: 200L Air compressor
Model number(s): Airmaster 18/200
Serial / batch Number: 2245311
Date of Issue: 13/07/2021
(Noise Conformity)
Notified Body: TÜV SÜD Certification & Testing China Co, Ltd
Shanghai ranch 3-13F
No 151 Heng Tong Road
Shanghai 200070
China

Technical Documentation Holder: A.R. Pond
Clarke International
2a Shrubland Road
London, E10 7RB
UK

Conformity Assessment Procedure: to 2000/14/EC Annex VI
Manufacturer: Clarke International
Noise Related Value: 3.0 kW
Measured Sound Power Level: 95 dB
Guaranteed Sound Power Level: 97 dB

DECLARATION OF CONFORMITY



We hereby declare that this product(s) complies with the following directive(s):

- 2014/30/EU *Electromagnetic Compatibility Directive.*
- 2006/42/EC *Machinery Directive.*
- 2011/65/EU *Restriction of Hazardous Substances (amended by (EU) 2015/863).*
- 2014/29/EU *Simple Pressure Vessel Directive.*
- 2000/14/EC *Noise Emissions Directive, (amended by 2005/88/EC).*

The following standards have been applied to the product(s):

EN 61000-6-3:2007+A1:2011, EN 61000-6-11:2007, EN 60204-1:2006+A1:2009, EN 1012-1:2010, EN 62321:2013, EN 62321-2:2014, EN 62321-3-1:2014, EN 62321-4:2014+A1:2017, EN 286-1, EN ISO 3744:1995.

The technical documentation required to demonstrate that the product(s) meet(s) the requirement(s) of the aforementioned directive(s) has been compiled and is available for inspection by the relevant enforcement authorities.

The CE mark was first applied in: 2021

Signed:

J.A. Clarke
Director

Machine Mart

A SELECTION OF OTHER QUALITY PRODUCTS



AIR COMPRESSORS
From DIY to industrial. Plus air tools,
spray guns and accessories.

GENERATORS
Prime duty or emergency standby
for business, home and leisure.

POWER WASHERS
Hot and cold, electric and engine
driven - we have what you need.

WELDERS
Mig, Arc, Tig and Spot. From DIY to
auto/industrial.

METALWORKING
Drills, grinders and saws for DIY and
professional use.

WOODWORKING
Saws, sanders, lathes, mortisers
and dust extraction.

HYDRAULICS
Cranes, body repair kits,
transmission jacks for all types of
workshop use.

WATER PUMPS
Submersible, electric and engine
driven for DIY, agriculture and
industry.

POWER TOOLS
Angle grinders, cordless drill sets,
saws and sanders.

STARTER/CHARGERS
All sizes for car & commercial use.

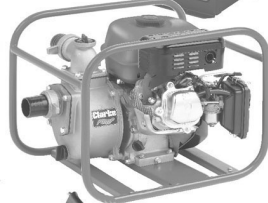

For Servicing and Spare Parts, please contact Machine Mart on one of the following numbers

PARTS: 0871 410 1270 SERVICE: 0871 410 1290